

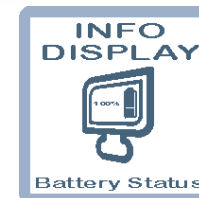

Smart Battery 220

Smart Battery for healthcare environment 

- ✓ Battery pack capacity : 8.7Ah @ 25.2V
- ✓ Up to 2 battery pack for each backplane
- ✓ Hot-Swap battery change : no service interruption
- ✓ Up to 8 hours service without battery change.
- ✓ Illuminated display with charge status indicator
- ✓ Charging station can up to charge two simultaneously battery pack

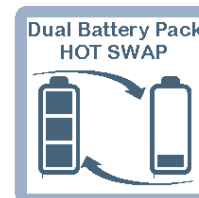
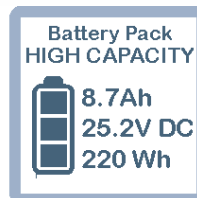

Smart Battery 220

Smart Battery for healthcare environment



Trolley Station	Capacity	2 x Battery pack 25.2V 8.7Ah	
	Max erogated current	12.4Ah with two battery pack	
	Maximum autonomy	Up to 8 hours* *estimated lifetime with the use of 2 x Battery pack 25.2V 8.7Ah in perfect working condition and 100% charge, used in combined with an Trolley system on medium configuration, 50% brightness and 70% of output processing power.	
	Battery change	Hot Swap	
	Modalità di sostituzione	By replacing 1 battery pack at a time, it is possible to guarantee continuity of service without interruptions * due to charging times. *To ensure continuity of service, the second battery pack present must have at least 30% residual charge.	
	Indicator	2 x battery pack detection led	
	Battery pack connection	2 x quick-fit connectors guaranteed for thousands of insertions.	
	Safety	- The quick-fit connectors are not powered until the battery pack is fully inserted. - The Trolley Station is equipped with a mechanical locking system that prevents accidental release of the battery pack.	
	Battery pack 220	Capacity	8.7Ah
		Voltage	25.2V DC Nominal voltage : 24V DC
Cell brand		Panasonic	
Display		1 x illuminated display with charge status indicator - Residual charge (%)	
Handling		The battery pack is easily removable thanks to an ergonomic handle and a quick-fit connector To ensure proper operation and life cycle, the battery pack must be stored with at least 70% charge and for periods not exceeding 6 months. For storage times longer than 6 months, charge maintenance cycles must be planned.	
Storage			
Mechanical features	Dimensions (L x A x P)	Complete dimensions including Trolley Station and 2 battery packs installed. See next pages 320 x 382.5 x 93 mm	
	Product cert.	Reference marks CE, RoHS Reference directive Build in conformity with European 2014/30/EU (EMCD), 2014/35/EU (LVD) and 2011/65/EU (RoHS)	
Company cert.	Ref. standards	UNI EN ISO 9001	

Charging Station	Capacity	2 x Battery pack 25.2V 8.7Ah
	Power input	90-264V AC, 47-63Hz, 60 W
	Charging time	At least 5 * hours with of 1 or 2 Battery Pack 220v independently. *Estimated charging time with battery pack in perfect working condition and at 20% of residual charge.
	Safety	The quick-fit connectors are not powered until the battery pack is fully inserted.
	Indicator	2 x battery pack detection led
Mechanical features	Internal battery charger	Compliant with regulations : EN60601-1, EN60950, EN60335-2-29, UL-60601-1, EN60601-1-2, EN61000-6-3, EN 61000-6-1
	Dimensions (L x A x P)	Complete dimensions including Charging Station and 2 Battery Packs installed. See next pages 320 x 382.5 x 133 mm
Product cert.	Reference marks	CE, RoHS
	Reference directive	Build in conformity with European 2014/30/EU (EMCD), 2014/35/EU (LVD) and 2011/65/EU (RoHS)
Company cert.	Ref. standards	UNI EN ISO 9001

Ordering code	BNSMBATT1-16-XX	SMART BATTERY 220 - SINGLE BATTERY PACK 220W/h
	CNSMBATT1A-19-XX	SMART BATTERY 220/300 - TROLLEY STATION - DOUBLE SLOT
	CNSMBATT1B-16-XX	SMART BATTERY 220/300 - CHARGING STATION - DOUBLE SLOT
	Doc Ref.	ZST-4292-00000039-01



Scan me



Intercomp S.p.A.
Via della Scienza 27, 37139, Verona, Italia
Tel +39 045-8378411 Fax +39 045-8510539
www.intercomp.it intercomp@intercomp.it



The product may differ from the images shown. All registered names and trademarks are legitimate owners. All features and specifications can be changed without prior notice.
Last update 24/04/2020

Smart Battery 220

Smart Battery for healthcare environment



Overall dimensions :
2 x Smart Battery220 + 1 x Trolley Station

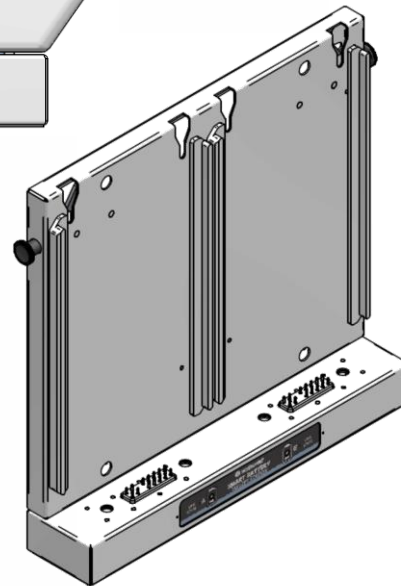
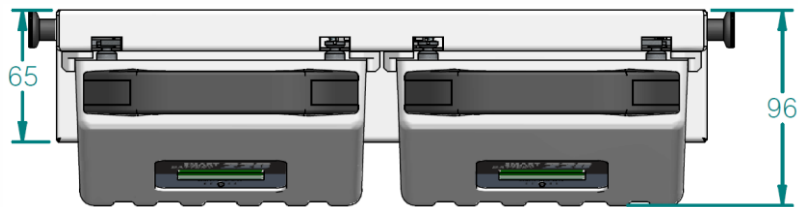
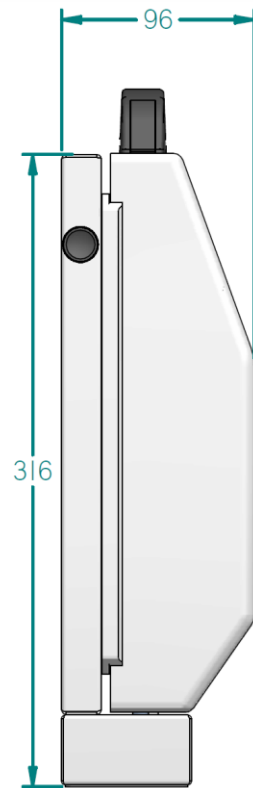

All dimensions are expressed in millimeters (mm)

Smart Battery 220

Smart Battery for healthcare environment



Overall dimensions :
2 x Smart Battery220 + 1 x Charging Station

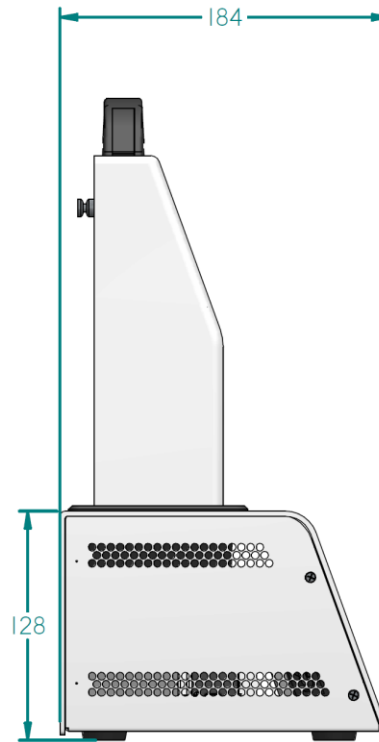
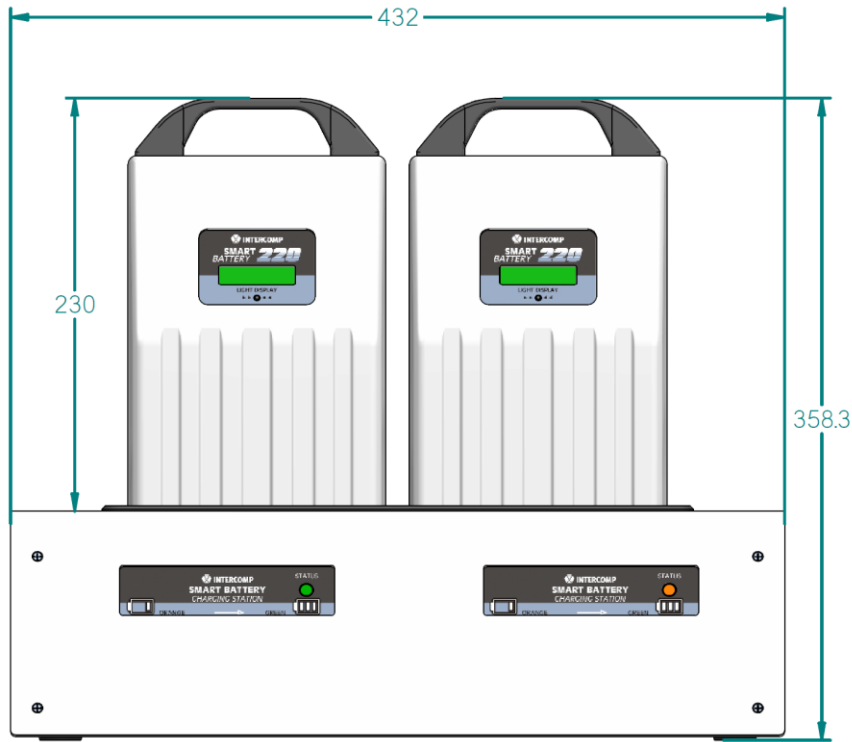

All dimensions are expressed in millimeters (mm)